

DESCRIPTION

- Various finishes identified by suffix
- Handheld shower with non-positive pause
- Double check valves in handshower

OPERATION

- 5-function: down pour, wide coverage, rinse, massage and combination: rotate outer ring to select

FLOW

- EP suffix models are limited to 1.75 gpm (6.7 L/min) max

STANDARDS

- Designed and manufactured to comply with the applicable requirements of ASME A112.18.1/CSA B-125.1 and ASSE 1014 and all applicable specifications referenced therein
- EP suffix models are third party certified to WaterSense®
- **ADA** ♿ for pause

WARRANTY

- Lifetime limited warranty against leaks, drips and finish defects to the original homeowner
- 10 year limited warranty when used in a multifamily installation
- 5 year limited warranty when used in a commercial installation

Visit www.moen.com/support for complete details and limitations

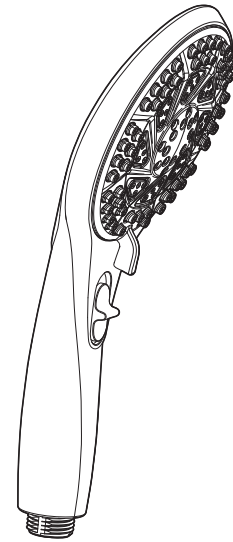

5-Function Massaging Handshower

Models: 198021 series

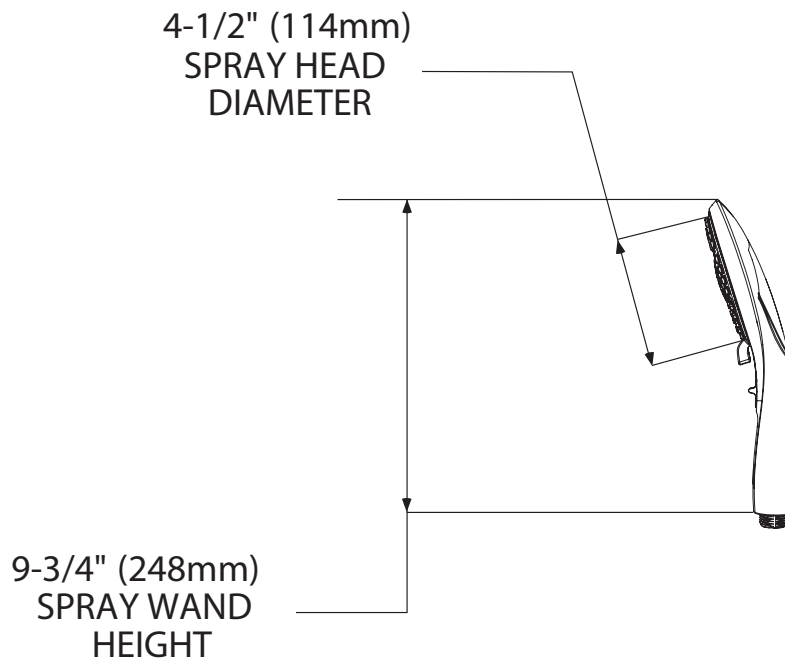

CRITICAL DIMENSIONS

(DO NOT SCALE)